

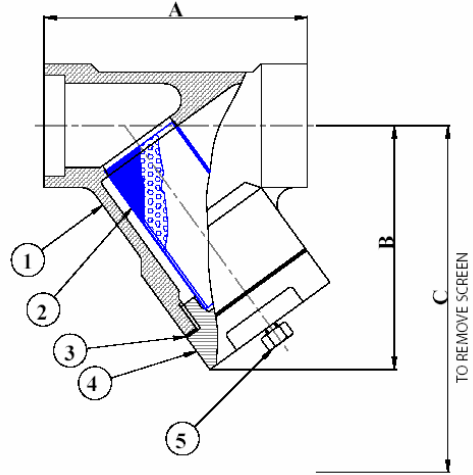

DATA SHEET: 16 – FIG Y1500 Y TYPE STRAINER

SIZES: ½” to 2” NB
PRESSURE: ANSI CLASS 1500
END CONNECTIONS: NPT/BSP/SW/BW
STANDARDS: ANSI B16.10.
CERTIFICATION: EN10204 3.1.B (C on request)
 NACE MR01-75
 PED97/23/EC (CE marked)
NDT: Hydro test as standard
 X Ray / MPI/DPI/PMI
 available on request
FINISH: None, as forged
 Special paint finish available
 on request



Dimensions approx (mm)

NB	A	B	C	Wt (Kg)
1/2”	110	75	140	1
3/4”	130	93	150	2
1”	160	120	195	6
1 1/2”	160	145	205	7
2”	190	160	280	10

NOTES

- 1) Drain plug – ¼” NPT on ½” to 1 ½” NB, ½” NPT on 2” NB. Flanged or SW drain available on request
- 2) Standard screen – 0.8 mm perf. Mesh lined available on request
- 3) Screwed covers on ½” to 1 ½” NB, bolted cover on 2” NB.
- 4) Screens are not pressure retaining items and should not be exposed to a differential pressure in excess of 0.5 Bar G without our consent.

Materials of construction

ITEM	CARBON STEEL	STAINLESS STEEL
1 BODY (FORGED)	ASTM A105N	ASTM A182 F316/L SS
2 SCREEN	316SS	316SS
3 COVER GASKET	Spiral wound 316SS / Non asbestos	Spiral wound 316SS / Non asbestos
4 COVER (FORGED)	ASTM A105N	ASTM A182 F316/L SS
5 DRAIN PLUG	ASTM A105N	ASTM A182 F316/L SS
6 BOLTING (On 2” only)	B7	B8

NOTES

- 1) Other materials including 304, 321, LF2, MONEL, F51 & F53 and other special alloys available on request
- 2) Special gaskets / bolting available on request

All data is subject to confirmation at the time of order. Our policy is one of continual improvement and we reserve the right to amend details without prior notice.